



Level Switch

NRS 1-51

EN
English

Original Installation Instructions
818955-04

Contents

Page

Application

Usage for the intended purpose	4
Function	4

Directives and Standards

Pressure Equipment Directive (PED) 2014/68/EU	5
Functional Safety acc. to IEC 61508	5
VdTÜV Bulletin "Wasserstand 100" (= Water Level 100)	5
LV (Low Voltage) Directive and EMC (Electromagnetic Compatibility)	5
ATEX (Atmosphère Explosible)	6
UL/cUL (CSA) Approval	6
Note on the Declaration of Conformity / Declaration by the Manufacturer CE	6

Functional Safety acc. to IEC 61508

Safety characteristics of the subsystem NRG 1...-51 / NRS 1-51	7
Terms and abbreviations	7
Determination of the Safety Integrity Level (SIL) for safety-related systems	8

Technical Data

NRS 1-51	9, 10
Name plate / marking	11

Dimensions and Functional Elements

NRS 1-51	12
----------------	----

Important Notes

Safety note	13
Scope of supply	13

Installation

Mounting level switch NRS 1-51	14
--------------------------------------	----

Electrical Connection

Connection of supply voltage	14
Connection of level electrode	14
Connection of control circuit	14
Connection of logic unit (standby input).....	15
Connection for signal output	15
Tools.....	15
Wiring diagram for level switch NRS 1-51.....	16
Schematic representations of arrangements	17
Explanatory notes to schematic representations.....	17

Basic Settings

Factory setting.....	17
----------------------	----

Commissioning Procedure

Checking switchpoint and function	18
---	----

Operation, Alarm and Test

Indicators and adjustors.....	19
-------------------------------	----

Troubleshooting

Indication, diagnosis and remedy.....	19, 20
---------------------------------------	--------

Further Notes

Action against high frequency interference	21
Interlock and interlock deactivation.....	21
Checking the switchpoints	21
Decommissioning / replacing level switch.....	21
Disposal.....	21

Application

Usage for the intended purpose

The level switch NRS 1-51 is used in conjunction with level electrodes NRG 1...-.. as high level alarm in steam boilers and (pressurised) hot-water plants.

A high level alarm prevents the water level from exceeding the preset max. water level (HW) and for this purpose switches off e. g. the feedwater supply.

Depending on the specified directives or standards, the level switch NRS 1-51 is intended to be used in combination with the following level electrodes:

Level electrode NRG 1...-..			
PED Pressure Equipment Directive 2014/68/EU + Functional Safety IEC 61508 SIL 3	NRG 16-51	NRG 17-51	NRG 19-51
VdTÜV Bulletin "Wasserstand 100" (= Water Level 100)	NRG 16-51 NRG 16-12	NRG 17-51 NRG 17-12	NRG 19-51 NRG 19-12

Function

The level switch NRS 1-51 is designed for different electrical conductivities of the boiler water and for connecting one level electrode.

See section **Schematic representations of arrangements** on page 16.

When the water level exceeds the MAX limit, the level electrode enters the liquid and an alarm is triggered in the level switch. This switchpoint is determined by the length of the electrode rod (level electrode NRG 1...-51, NRG 1...-12).

After the de-energizing delay has elapsed, both output contacts of the level switch will open the control circuit, e. g. for the feedwater supply. If the deactivation of the feedwater supply is interlocked in the external control circuit, the lockout can only be deactivated when the level electrode is exposed again.

An alarm will also be raised if a malfunction occurs in the level electrode and/or the electrical connection.

If the level electrode is installed in an isolatable level pot outside the boiler, make sure that the connecting lines are rinsed regularly. During the rinsing process the water level cannot be measured in the level pot for 5 minutes. The level switch therefore bypasses the level electrode and monitors the rinsing and bypass time (standby input, controlled by the logic unit SRL 6-50).

If the connecting lines for steam ≥ 40 mm and water ≥ 100 mm, the installation is considered to be internal. In this case the rinsing processes do not have to be monitored.

An automatic self-testing routine monitors the safety functions of the level switch. In the event of a malfunction the control circuit opens instantaneously and switches off e. g. the feedwater supply.

Alarm and malfunction messages are indicated by LEDs, and the signal output is instantaneously energized.

An alarm can be simulated by pressing the test button.



Note

- A high level alarm prevents the water level from exceeding the preset max. liquid level (HW). For this purpose it can, for instance, interrupt the feedwater supply. If the interruption of the feedwater supply endangers the heating surfaces in the feedwater preheater (economizer), the heating must be switched off, too.

Directives and Standards

Pressure Equipment Directive (PED) 2014/68/EU

The level switch NRS 1-51 in conjunction with level electrode NRG 1...-51 is EC type approved according to EN 12952/EN 12953. These Directives state, among other things, the requirements made on limiting systems and equipment for steam boiler plants and (pressurised) hot-water installations.

Functional Safety acc. to IEC 61508

The level switch NRS 1-51 is certified acc. to IEC 61508 only if used in combination with level electrode NRG 1...-51. This standard describes the functional safety of safety-related electrical/electronic/programmable electronic systems.

The equipment combination NRG 1...-51 + NRS 1-51 corresponds to a type B subsystem with Safety Integrity Level (SIL) 3.

VdTÜV Bulletin "Wasserstand 100" (= Water Level 100)

The level switch NRS 1-51 in conjunction with the level electrodes NRG 1...-51 and NRG 1...-12 is type approved according to the VdTÜV Bulletin "Water Level 100".

The VdTÜV Bulletin "Wasserstand (= Water Level) 100" specifies the requirements made on water level control and limiting equipment for boilers.

LV (Low Voltage) Directive and EMC (Electromagnetic Compatibility)

The level switch NRS 1-51 meets the requirements of the Low Voltage Directive 2014/35/EU and the EMC Directive 2014/30/EU.

Directives and Standards – continued –

ATEX (Atmosphère Explosible)

According to the European Directive 2014/34/EU the level switch NRS 1-51 must **not** be used in potentially explosive areas.



Note

The level electrodes NRG 1...-51, NRG 1...-12 are simple items of electrical equipment as specified in EN 60079-11 section 5.7. According to the European Directive 2014/34/EU the equipment must be equipped with approved Zener barriers if used in potentially explosive areas. Applicable in Ex zones 1, 2 (1999/92/EC).

The equipment does not bear an Ex marking.

Note that the requirements of the IEC 61508 are not met if the NRG 1...-51, NRG 1...-12 + Zener barriers + NRS 1-51 are interconnected!

UL/cUL (CSA) Approval

The equipment meets the requirements of Directives: UL 508 and CSA C22.2 No. 14-13, Standards for Industrial Control Equipment. File E243189.

Note on the Declaration of Conformity / Declaration by the Manufacturer

For details on the conformity of our equipment according to the European Directives see our Declaration of Conformity or our Declaration of Manufacturer.

The current Declaration of Conformity / Declaration of Manufacturer are available in the Internet under www.gestra.de ► Documents or can be requested from us.

Functional Safety acc. to IEC 61508

Safety characteristics of the subsystem NRG 1...-51 / NRS 1-51

The level switch NRS 1-51 is certified acc. to IEC 61508 only if used in combination with level electrodes NRG 1...-51.

The equipment combination NRG 1...-51 / NRS 1-51 corresponds to a type B subsystem with Safety Integrity Level (SIL) 3. Type B means that the behaviour under fault conditions of the used components cannot be completely determined. The functional safety of the equipment combination refers to the detection and evaluation of the water level and, as a consequence, the contact position of the output relays.

The design of the equipment combination NRG 1...-51 / NRS 1-51 corresponds to the architecture 1oo2. This architecture consists of two channels that detect and diagnose faults in each other. If a fault is detected, the equipment combination NRG 1...-51 / NRS 1-51 will go to the safe state, which means that the contacts of both output relays will open the control circuit.

Safety characteristics	SIL	Architecture	Lifetime (a)	Proof Test Interval (a)
General	3	1oo2	20	20
	SFF	PFD _{av}	PFH _{av}	λ_{DU}
Level switch NRS 1-51 alone	98.54 %	1.18×10^{-4}	3.73×10^{-8}	$7.33 \times 10^{-8}/h$
Level switch NRS 1-51 in conjunction with one level electrode NRG 1...-51	98.17 %	1.69×10^{-4}	4.54×10^{-8}	$9.33 \times 10^{-8}/h$

Fig. 1

Terms and abbreviations

Terms Abbreviations	Description
Safety Integrity Level SIL	Classification of the Safety Integrity Level acc. to IEC 61508
Lifetime (a)	Functional safety: Lifetime in years
Safe Failure Fraction SFF	Percentage of failures without the potential to put the safety-related system into a dangerous state
Probability Failure per Demand (Low Demand) PFD _{av}	Average probability of failure on demand for low demand mode (once a year)
Probability Failure per Hour PFH _{av}	Probability of failure per hour
λ_{DU}	Failure rate for all dangerous undetected failures (per hour) of a channel of a subsystem

Fig. 2

Determination of the Safety Integrity Level (SIL) for safety-related systems

Level electrode, level switch and actuators (auxiliary contactors in control circuit) are subsystems and together constitute a safety-related system that executes a safety function.

The specification of the safety-related characteristics **Fig. 1** refers to the level electrode and the level switch including the output contacts. The actuator (e. g. an auxiliary contactor in the control circuit) is installation specific and, according to IEC 61508, must be considered separately for the whole safety-related system.

Table **Fig. 3** shows the dependence of the Safety Integrity Level (SIL) on the average probability of failure on demand of a safety function for the **whole** safety-related system (PFD_{sys}). The “Low demand mode” is here considered for a water level limiter, which means that the frequency of demands for operation of the safety-related system is no greater than one per year.

Low demand mode PFD_{sys}	Safety Integrity Level (SIL)
$\geq 10^{-5} \dots < 10^{-4}$	4
$\geq 10^{-4} \dots < 10^{-3}$	3
$\geq 10^{-3} \dots < 10^{-2}$	2
$\geq 10^{-2} \dots < 10^{-1}$	1

Fig. 3

The table in **Fig. 4** indicates the attainable Safety Integrity Level (SIL) as a function of the Safe Failure Fraction (SFF) and the Hardware Fault Tolerance (HFT) for safety-related systems.

Hardware Fault Tolerance (HFT) for type B			Safe Failure Fraction (SFF)
0	1	2	
	SIL 1	SIL 2	< 60 %
SIL 1	SIL 2	SIL 3	60 % – < 90 %
SIL 2	SIL 3	SIL 4	90 % – < 99 %
SIL 3	SIL 4	SIL 4	≥ 99 %

Fig. 4

Technical Data

NRS 1-51

Supply voltage

24 VDC \pm 20 %, 0.3 A;
100 – 240 VAC \pm 10/–15 %, 47 – 63 Hz, 0.2 A (optional)

External fuse

0.5 A (semi-delay)

Power consumption

7 VA

Response sensitivity (Electrical conductivity of water at 25 °C)

$> 0.5 \dots < 1000 \mu\text{S/cm}$ or
 $> 10 \dots < 10000 \mu\text{S/cm}$

Electrical connection of level electrode

1 input for level electrode NRG 1...-51, NRG 1...-12, 4-poles with screen
Sensitivity $0.5 \mu\text{S/cm}$ or $10 \mu\text{S/cm}$ (at 25 °C).

Stand-by input

1 volt-free input, 18-36 VDC, for monitoring the purging and bypass time.
Max. bypass time: 5 minutes.

Control circuit

2 volt-free make contacts, 6 A 250 V AC / 30 V DC $\cos \varphi = 1$.

Delay of response: 3 seconds.

Provide inductive loads with RC combinations according to manufacturer's specification to ensure interference suppression.

Signal output

1 volt-free output for instantaneous external signalling, 24 V DC, max. 100 mA (semiconductor output).

Indicators and adjustors

2 buttons for test and diagnosis,

2 red/green LEDs for indicating the operating mode and alarm.

3 red LEDs for diagnosis.

Housing

Housing material: base: polycarbonate, black; front: polycarbonate, grey.

Cross section of connection: $1 \times 4.0 \text{ mm}^2$ solid per wire or

$1 \times 2.5 \text{ mm}^2$ per stranded wire with sleeve to DIN 46228 or

$2 \times 1.4 \text{ mm}^2$ per stranded wire with sleeve to DIN 46228; terminal strips can be detached

Fixing of housing: Mounting clip on supporting rail TH 35, EN 60715

Electrical safety

Degree of contamination: 2, overvoltage category III to EN 61010-01.

Protection

Housing: IP 40 to EN 60529

Terminal strip: IP 20 to EN 60529

Weight

approx. 0.5 kg

Further conditions:

Ambient temperature

when system is switched on: 0 ... 55 °C

during operation: –10 ... 55 °C

Transport temperature

–20 ... +80 °C (< 100 hours), defrosting time of the de-energized equipment before it can be put into operation: 24 hours.

Storage temperature

–20 ... +70 °C, defrosting time of the de-energized equipment before it can be put into operation: 24 hours.

Relative humidity

max. 95%, no moisture condensation

Site altitude

max. 2000 m

Approvals

EC Prototype approval

PED Pressure Equipment Directive 2014/68/EU
EN 12952-11, EN 12953-09: Requirements made on
limiting equipment for boilers.

Functional safety

SIL 3

IEC 61508 Functional safety of safety-related electrical/
electronic/programmable electronic systems

TÜV type approval





VdTÜV Bulletin “Wasserstand 100” (= Water Level 100):
Requirements made on water level limiting & control equipment.

Type approval no. TÜV · SHWS · XX-423
(see name plate)

UL/cUL (CSA) Approval

UL 508 and CSA C22.2 No. 14-13, Standards for Industrial Control
Equipment. File E243189.

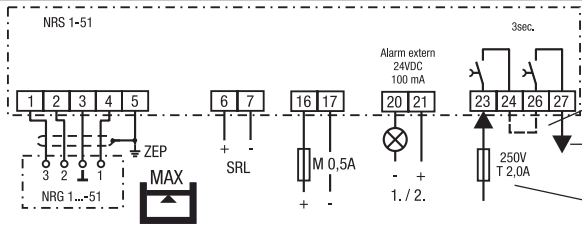
Name plate / marking

Safety note		Betriebsanleitung beachten See installation instructions Voir instructions de montage	Niveauschalter Level switch Commutateur de niveau		NRS 1 - 51		Type designation	
			24V = + / - 20%	7 VA	IP 40 (IP20)		Supply voltage/ Protection	
			Tamb = 55°C (131°F)		10 µS/cm		Ambient temperature / sensitivity	
Wiring diagram								Wire link, provided on site
								Control circuit
								Fuse, provided on site
Manufacturer	Funktionale Sicherheit Functional safety Sécurité fonctionnelle IEC 61508 SIL 3		Hochwasserstandsicherung High water level limiter Limiteur de niveau d'eau haut				Type approval no.	
	GESTRA AG Münchener Str. 77 D-28215 Bremen		TÜV · SHWS · XX-423		0525			
	Serial number						Disposal note	





Safety note		Betriebsanleitung beachten See installation instructions Voir instructions de montage	Niveauschalter Level switch Commutateur de niveau		NRS 1 - 51		Type designation	
			24V = + / - 20%	7 VA	IP 40 (IP20)		Supply voltage/ Protection	
			Tamb = 55°C (131°F)		0,5 µS/cm		Ambient temperature / sensitivity	
Wiring diagram								Wire link, provided on site
								Control circuit
								Fuse, provided on site
Manufacturer	Funktionale Sicherheit Functional safety Sécurité fonctionnelle IEC 61508 SIL 3		Hochwasserstandsicherung High water level limiter Limiteur de niveau d'eau haut				Type approval no.	
	GESTRA AG Münchener Str. 77 D-28215 Bremen		TÜV · SHWS · XX-423		0525			
	Serial number						Disposal note	

Fig. 5

Dimensions and Functional Elements

NRS 1-51

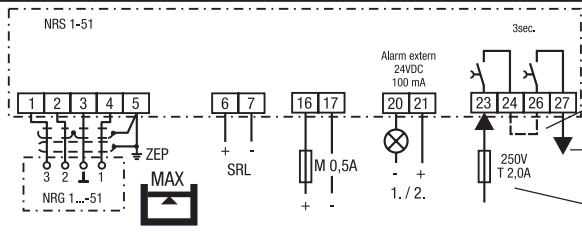
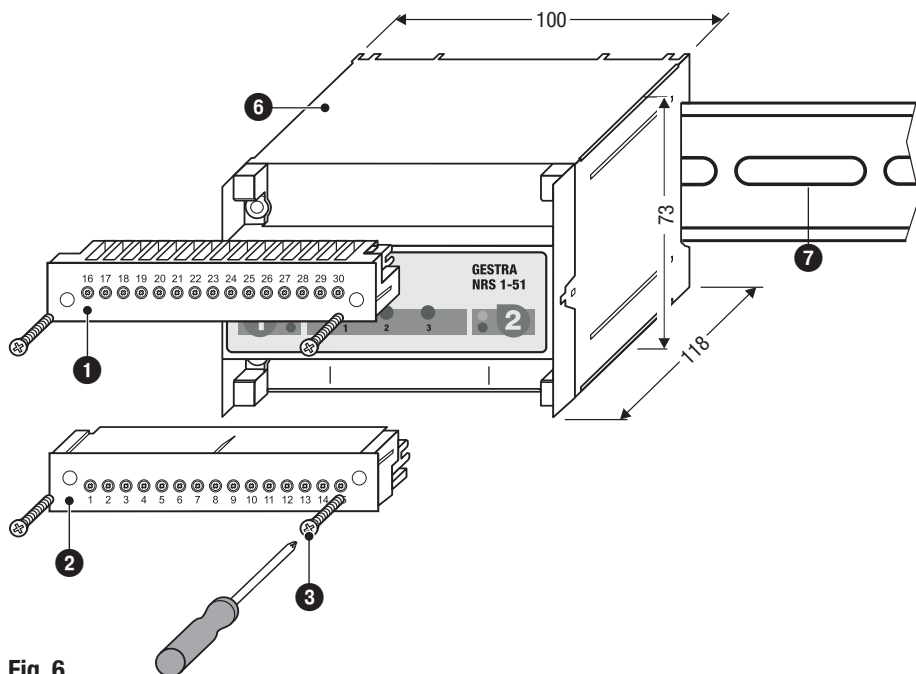

Fig. 6

Key

- ① Upper terminal strip
- ② Lower terminal strip
- ③ Fixing screws (cross recess head screws M3)
- ⑥ Enclosure
- ⑦ Supporting rail type TH 35, EN 60715

Important Notes

Safety note

High water level alarms are safety devices and must only be installed, wired and commissioned by qualified and competent staff.

Retrofitting and maintenance work must only be performed by qualified staff who – through adequate training – have achieved a recognised level of competence.



Danger

The terminal strips of the NRS 1-51 are live during operation.

This presents the danger of electric shock!

Always **cut off power supply** to the equipment before mounting, removing or connecting the terminal strips!



Attention

The name plate specifies the technical features of the equipment. Note that any piece of equipment without its specific name plate must neither be commissioned nor operated.

Scope of supply

NRS 1-51

1 Level switch NRS 1-51

1 Installation manual

Installation

Mounting level switch NRS 1-51

The level switch NRS 1-51 is clipped onto the support rail ⑦ type TH 35, EN 60715 in the control cabinet. **Fig. 6**

Electrical Connection

Connection of supply voltage

Provide the level switch NRS 1-51 with an external semi-delay fuse 0.5 A. If the equipment is supplied with 24 V DC use a safety power supply unit with safe electrical isolation.

The power supply unit must be electrically isolated from dangerous contact voltages and must meet at least the requirements on double or reinforced isolation according to one of the following standards: DIN EN 50178, DIN EN 61010-1, DIN EN 60730-1 or DIN EN 60950.

Connection of level electrode

To connect the level electrode please use:

- For level switch NRS 1-51 with response sensitivity 10 μ S:
Screened multi-core control cable, min. conductor size 0.5 mm², e.g. LiYCY 4 x 0.5 mm², max. length 100 m.
- For level switch NRS 1-51 with response sensitivity 0.5 μ S:
Double-screened multi-core low-capacitance data cable, min. conductor size 0.5 mm², **Li2YCY PiMF 2 x 2 x 0.5 mm², max. length 30 m.**

Wire terminal strip in accordance with the wiring diagram. **Fig. 7.** Connect screens to terminal 5 and to the central earthing point (**CEP**) in the control cabinet.

Connection of control circuit

Connect the control circuit for the feedwater supply / heating to terminals 23, 24 and 26, 27. Wenn used as high water level alarm to TRD, EN 12952 / EN 12953 connect the output contacts of both monitoring channels by fitting a wire link between the terminals 24 and 26.

Fuse the output contacts with a 2 A or 1 A (for 72 hours operation acc. to TRD 604) slow-blow fuse.



Note

- A high level alarm prevents the water level from exceeding the preset max. liquid level (HW). For this purpose it can, for instance, interrupt the feedwater supply. If the interruption of the feedwater supply endangers the heating surfaces in the feedwater preheater (economizer), the heating must be switched off, too.
- In the event of an alarm the level switch NRS 1-51 does not interlock automatically. If a lockout function is required by the installation it must be provided in the follow-up circuitry (control circuit). The circuitry must meet the requirements of the EN 50156.

Electrical Connection – continued –

Connection of logic unit (standby input)

For connecting the level switch with the logic unit use a control cable, e. g. 2 x 0.5 mm². The control voltage must not exceed 36 V DC.

Connection for signal output

A signal output for the connection of external signalling equipment is allocated to the monitoring channel in the level switch, max. load 100 mA. For connecting the level switch with the logic unit use a control cable, e.g. 2 x 0.5 mm². In the event of an alarm or error message the signal output (terminals 20, 21) closes instantaneously.



Danger

- For the supply of the level switch NRS 1-51 with 24 V DC use a safety extra-low voltage (SELV) power supply unit that must be electrically isolated from dangerous contact voltages and must meet at least the requirements on double or reinforced isolation acc. to DIN EN 50178 or DIN EN 61010-1 or DIN EN 60730-1 or DIN EN 60950 (safe electrical isolation).
- Any item of equipment that you want to connect to terminals 6, 7 (standby input 1) must be certified to have at least double or reinforced isolation according to DIN EN 50178 or DIN EN 61010-1 or DIN EN 60730-1 or DIN EN 60950 (safe electrical isolation) between the standby inputs and the live parts of the installation that are not supplied with safety extra-low voltage (SELV).



Attention

- Fuse the level switch NRS 1-51 with an external semi-delay fuse 0.5 A.
- Connect screens to terminal 5 and to the central earthing point (**CEP**) in the control cabinet.
- To protect the switching contacts fuse the safety circuit with a slow-blow fuse 2 A or 1 A (for 72 hrs. operation acc. to TRD 604).
- When switching off inductive loads, voltage spikes are produced that may impair the operation of control and measuring systems. Connected inductive loads must be provided with suppressors such as RC combinations as specified by the manufacturer.
- When used as high water level alarm according to TRD, EN 12952 / EN 12953 connect terminals 24 and 26 by fitting a wire link.
- Install connecting lines to level electrodes and logic unit separated from power cables.
- Do not use unused terminals as support point terminals.

Tools

- Screwdriver for slotted screws, size 3.5 x 100 mm, completely insulated according to VDE 0680-1.

Wiring diagram for level switch NRS 1-51

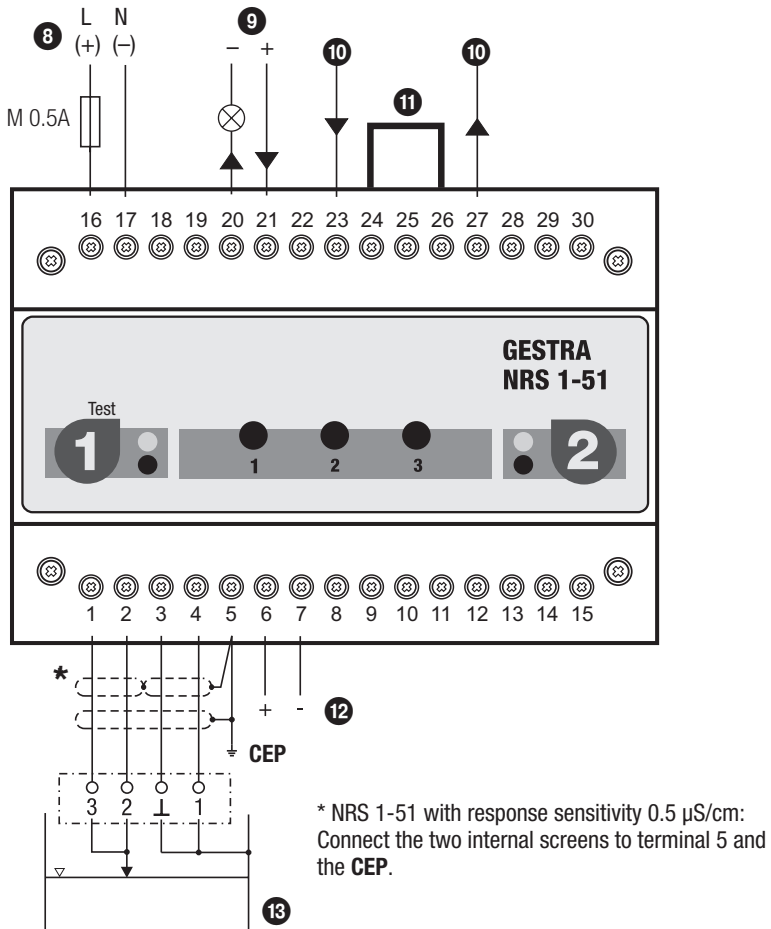

Key

- 8** Mains supply
- 9** Signal output 1 for external alarm 24-230 V AC/DC 100 mA
- 10** Control circuit, input and output
- 11** Wire link, fitted on site, when used as high water level alarm acc. to TRD, EN 12952 / EN 12953
- 12** Stand-by input 1, 24 V DC, for connecting the logic unit SRL 6-50
- 13** Level electrode NRG 1...-51, NRG 1...-12

CEP Central earthing point in control cabinet

Schematic representations of arrangements

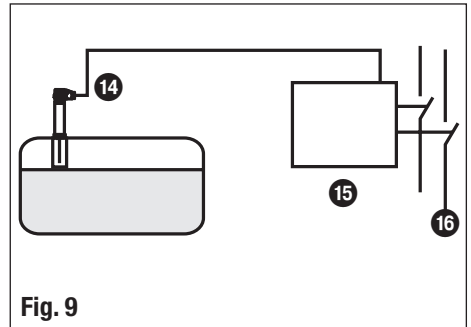
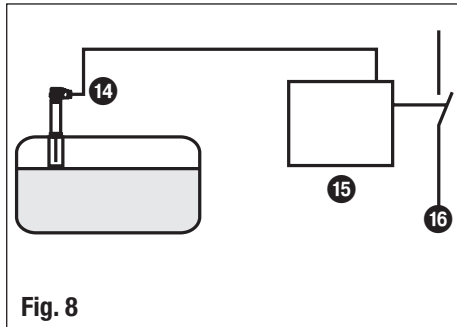

Key

Steam boiler plants according to TRD 604, EN 12952-07 / EN 12953-06, 72 h operation

Fig. 8

Combination consisting of 1 level electrode NRG 1...-51 and 1 level switch NRS 1-51 as high water level alarm. Functional safety IEC 61508, SIL 3.

Further applications in accordance with national sets of regulations

Fig. 9

Combination consisting of 1 level electrode NRG 1...-51 and 1 level switch NRS 1-51 as high water level alarm. The level switch opens two separate control circuits. Functional safety IEC 61508, SIL 3.

- 14 Level electrode(s) NRG 1...-51
- 15 Level switch NRS 1-51
- 16 Control circuit

Basic Settings

Factory setting

Level Switch NRS 1-51

The level switch features the following factory set default values:

- De-energizing delay: 3 sec.

Commissioning Procedure



Danger

The terminal strips of the NRS 1-51 are live during operation.

This presents the danger of electric shock!

Always **cut off power supply** to the equipment before mounting, removing or connecting the terminal strips!

Checking switchpoint and function

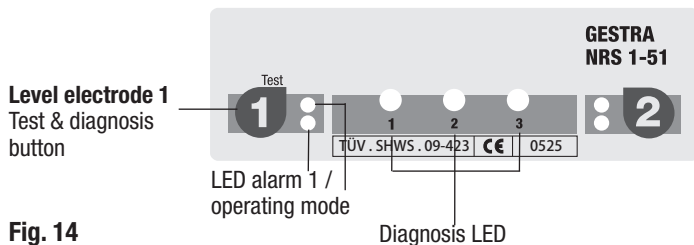

Fig. 14

Start		
Activity	Indication	Function
Apply mains voltage.	All LEDs are illuminated.	System is being started and tested, this takes approx. 10 sec. Output contacts are open. Signal output 1 closed.
	All LEDs are illuminated for more than 10 sec.	System malfunction. Possible causes: Faulty power supply, level switch defective.
Lower water level in boiler until the level falls below the switchpoint high water level (HW). Level electrode is exposed.	Green LED for level electrode 1 is illuminated	Output contacts are closed. Signal output 1 is open.

Checking switchpoint and function		
Raise level in boiler until the switchpoint “high water level (HW)” is exceeded. Level electrode enters the water.	Red LED for level electrode 1 is flashing	De-energizing delay is running. Signal output 1 is closed instantaneously.
	Red LED for level electrode 1 is illuminated	Delay time has elapsed, output contacts open. Signal output 1 is closed.

Possible installation faults		
Status and indication	Fault	Remedy
Sightglass indicates high water level (HW) exceeded, red LED for level electrode 1 is not illuminated. Safety circuit closed.	The electrode rod is too short.	Replace electrode rod and cut new rod to the length dictated by the switchpoint HW.
	The earth connection to the vessel is interrupted.	Clean seating surfaces and screw in level electrode with metallic joint ring. Do not insulate the electrode with hemp or PTFE tape!
	Electrical conductivity of the boiler water too low.	Set response sensitivity of the level switch to 0.5 µS/cm.
	If installed inside the boiler: Upper vent hole in protection tube does not exist or is obstructed.	Check installation of level electrode. Make sure that the level in the protection tube corresponds to the actual water level.
Water level sufficient. Red LED for level electrode 1 is illuminated. Safety circuit is open.	Electrode rod is too long.	Cut electrode rod to the length dictated by the switchpoint HW.
	Upper vent hole flooded.	Check installation of level electrode. Make sure that the level in the protection tube corresponds to the actual water level.

Operation, Alarm and Test

Indicators and adjustors

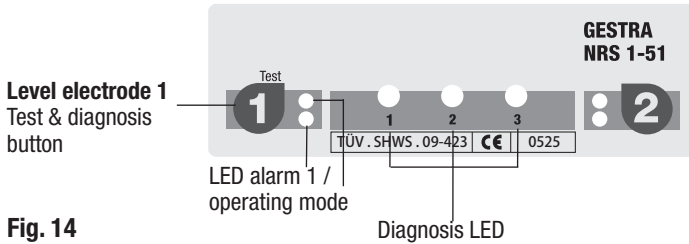

Fig. 14

Operation		
Activity	Indication	Function
Level electrode exposed	Green LED for level electrode 1 is illuminated	Output contacts are closed. Signal output 1 is open.

Alarm		
Level electrode submerged, high water level (HW) exceeded.	Red LED for level electrode 1 is flashing	De-energizing delay is running. Signal output 1 is closed instantaneously.
	Red LED for level electrode 1 is illuminated	Delay time has elapsed, output contacts open. Signal output 1 is closed.

Test channel 1		
During operation: Press and hold down key 1 until the end of the test, level switch must function as if there were an alarm.	Red LED for level electrode 1 is flashing	Alarm simulated in channel 1 or 2. De-energizing delay is running. Signal output 1 is closed instantaneously.
	Red LED for level electrode 1 is illuminated	Delay time has elapsed, output contacts open. Signal output 1 is closed. Test finished.
Replace level switch if the test was not finished successfully.		

Troubleshooting

Indication, diagnosis and remedy



Attention

Before carrying out the fault diagnosis please check:

Mains supply:

Is the level switch supplied with the supply voltage specified on the name plate?

Wiring:

Is the wiring in accordance with the wiring diagram and the relevant schematic representation of arrangement?

Troubleshooting – continued –

Indication, diagnosis and remedy – continued –

Malfunction in level electrode		
Status and indication	Fault	Remedy
Water level sufficient. Red LED for level electrode 1 is illuminated. Safety circuit is open.	The insulation of the level electrode is dirty or faulty.	Clean or, if necessary, replace level electrode.

Further fault indications			
Status	Diagnosis	Function	Next activity
Faulty evaluation of level electrode 1, channel 1	Diagnosis LED 1 and LED alarm 1 illuminated.	Output contacts are opened instantaneously. Signal output 1 closes instantaneously.	next: Press key 1 .
Malfunction in level switch detected.	Diagnosis LED 3 and LED alarm 1 or 2 illuminated.	Output contacts are opened instantaneously. Signal outputs 1/2 are closed instantaneously.	next: Press key 1 or key 2 .

Diagnosis			
Display 1 and activity	Display 2	Fault	Remedy
LED alarm 1 and diagnosis LED 1 illuminated. Press and hold down key 1 .	Diagnosis LED 1 flashing.	Malfunction in level electrode 1, malfunction in level switch, faulty wiring, faulty measuring voltage.	Check wiring, replace level switch.
	Diagnosis LED 2 flashing.	Malfunction in level electrode 1, malfunction in level switch, faulty wiring.	
	Diagnosis LED 3 flashing.	Interference voltage causing malfunction, boiler earth without PE	Provide screen and earthing, connect boiler with PE.
LED alarm 1 or 2 and Diagnosis LED 3 illuminated. Press and hold down key 1 or 2 .	Diagnosis LED 1 flashing.	Malfunction in processor, stand-by fault.	Observe operating instructions for the logic unit SRL. Replace level switch. Replace level switch.
	Diagnosis LED 2 flashing.	Internal voltage fault.	
	Diagnosis LED 3 flashing.	Malfunction in relay.	
Once the fault is eliminated, the level switch returns to normal operation. After elimination of the fault switch off the supply voltage and switch it on again after approx. 5 sec.			

If faults occur that are not listed above or cannot be corrected, please contact our service centre or authorized agency in your country.

Further Notes

Action against high frequency interference

Should sporadic failures occur in installations susceptible to faults (e. g. malfunctions due to out-of-phase switching operations) we recommend the following actions in order to suppress interferences:

- Provide inductive loads with RC combinations according to manufacturer's specification to ensure interference suppression.
- Make sure that connecting cables leading to the level electrodes are segregated and run separately from power cables
- Increase the distance to sources of interference.
- Check the connection of the screen to the central earthing point (CEP) in the control cabinet.
- HF interference suppression by means of hinged-shell ferrite rings.

Interlock and interlock deactivation

In the event of an alarm the level switch NRS 1-51 does not interlock automatically.

If a lockout function is required by the installation it must be provided in the follow-up circuitry (control circuit). The circuitry must meet the requirements of the EN 50156.

Checking the switchpoints

To check the switchpoint "High water level (HW) exceeded" you have to fill the boiler until the max. water level is reached. As soon as the high level is reached the level switch must trigger an alarm and open the control circuit after the de-energizing delay has elapsed. The deactivation of the heating is interlocked in the control circuit and the lockout can only be reset when the level electrode is exposed again. Always check the switchpoint when commissioning the equipment, after replacing the level electrode and at regular intervals, e. g. every year.

Decommissioning / replacing level switch

- Switch off supply voltage and **cut off power supply** to the equipment.
- Unscrew the right and left fixing screws ③ and remove the upper and lower terminal strips ① ②, Fig. 6
- Undo the fixing slide in order to snap out the level switch and take it off the supporting rail.

Disposal

Remove the level switch and separate the waste materials in accordance with the material specification.

Electronic component parts such as the circuit board must be disposed of separately!

For the disposal of the levels switch observe the pertinent legal regulations concerning waste disposal.



Agencies all over the world: www.gestra.de

GESTRA AG

Münchener Straße 77

28215 Bremen

Germany

Telefon +49 421 3503-0

Telefax +49 421 3503-393

E-mail info@de.gestra.com

Web www.gestra.de